

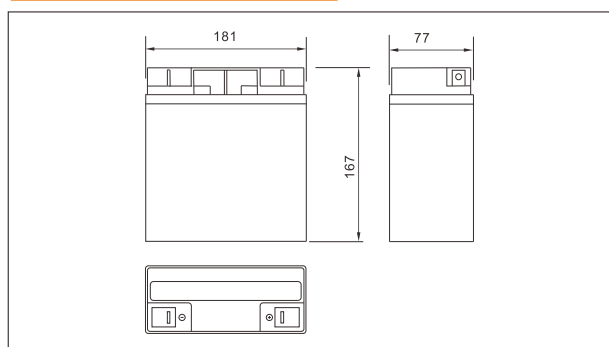

● Specifications

| | | |
|-------------------------------|--------------|-------------------|
| Nominal Voltage | | 12V |
| Rated capacity (20 hour rate) | | 20Ah |
| Dimensions | Length | 181±2mm(7.13inch) |
| | Width | 77±1mm(3.03inch) |
| | Height | 167±2mm(6.57inch) |
| | Total Height | 167±2mm(6.57inch) |
| Approx. Weight | | 5.5kg(12.1lbs)±4% |

● Outer dimensions (mm)



● Terminal Type (mm)

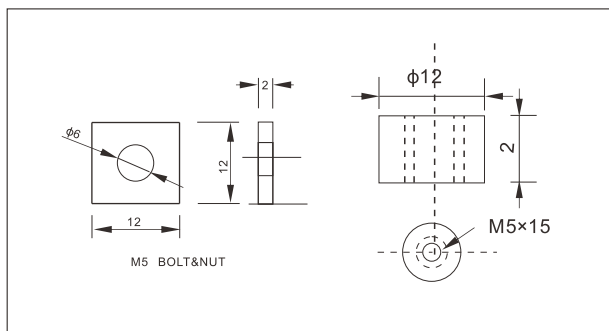

● Characteristics

| | | |
|---|-------------|---|
| Capacity (25°C) | 20HR(10.5V) | 20Ah |
| | 10HR(10.5V) | 18.5Ah |
| | 1HR(9.60V) | 12Ah |
| Terminal type | | T3/T12 |
| Internal resistance (Fully charged, 25°C) | | Approx. 12m Ω |
| Capacity affected by temperature (20HR) | 40°C | 102% |
| | 25°C | 100% |
| | 0°C | 85% |
| | -15°C | 65% |
| Self-discharge (25°C) | 3month | Remaining Capacity:91% |
| | 6month | Remaining Capacity:82% |
| | 12month | Remaining Capacity:65% |
| Nominal operating temperature | | 25°C± 3C (77°F±5 °F) |
| Operating temperature range | Discharge | -15°C~50°C(5°F~122°F) |
| | Charge | -10°C~50°C(14°F~122°F) |
| | Storage | -20°C~50°C(-4°F~122°F) |
| Float charging voltage(25°C) | | 13.50 to 13.80V Temperature compensation: -18mV/°C |
| Cyclic charging voltage(25°C) | | 14.50 to 15.00V Temperature compensation: -30mV/°C |
| Maximum charging current | | 6A |
| Maximum discharge current | | 300A(5 sec.) |
| Designed floating life(20°C) | | 5 years |

● Construction

| Component | Positive plate | Negative plate | Container | Cover | Separator | Electrolyte | Safety valve | Terminal |
|--------------|----------------|----------------|-----------|-------|-----------|---------------|--------------|----------|
| Raw material | Lead dioxide | Lead | ABS | ABS | AGM | Sulfuric acid | Rubber | Copper |

● Constant Current Discharge Characteristics Unit:A(25°C,77°F)

| F.V/Time | 5min | 10min | 15min | 30min | 60min | 2h | 3h | 4h | 5h | 10h | 20h |
|----------|------|-------|-------|-------|-------|------|------|------|------|------|------|
| 9.60V | 76.4 | 48.4 | 37.8 | 21.3 | 13.1 | 7.17 | 4.96 | 4.10 | 3.49 | 1.89 | 1.02 |
| 9.90V | 74.1 | 46.9 | 36.9 | 20.9 | 12.9 | 7.12 | 4.93 | 4.08 | 3.47 | 1.89 | 1.01 |
| 10.2V | 71.1 | 45.0 | 35.5 | 20.2 | 12.6 | 7.06 | 4.89 | 4.05 | 3.44 | 1.88 | 1.01 |
| 10.5V | 68.0 | 43.1 | 34.3 | 19.7 | 12.3 | 6.95 | 4.86 | 4.02 | 3.42 | 1.87 | 1.00 |
| 10.8V | 64.2 | 40.7 | 32.5 | 19.0 | 11.9 | 6.78 | 4.71 | 3.90 | 3.32 | 1.83 | 0.98 |

● Constant Power Discharge Characteristics Unit:W(25°C,77°F)

| F.V/Time | 5min | 10min | 15min | 30min | 60min | 2h | 3h | 4h | 5h | 10h | 20h |
|----------|------|-------|-------|-------|-------|------|------|------|------|------|------|
| 9.60V | 853 | 546 | 431 | 244 | 152 | 83.8 | 58.9 | 48.8 | 41.7 | 22.7 | 12.2 |
| 9.90V | 827 | 530 | 421 | 239 | 149 | 83.3 | 58.5 | 48.5 | 41.4 | 22.6 | 12.1 |
| 10.2V | 793 | 508 | 405 | 232 | 146 | 82.6 | 58.1 | 48.2 | 41.1 | 22.5 | 12.1 |
| 10.5V | 759 | 486 | 391 | 226 | 143 | 81.4 | 57.7 | 47.9 | 40.8 | 22.4 | 12.0 |
| 10.8V | 716 | 459 | 371 | 218 | 138 | 79.3 | 56.0 | 46.4 | 39.6 | 21.9 | 11.8 |

Note: The above characteristics data can be obtained within three charge or discharge cycles.

● Discharge characteristics(25°C)

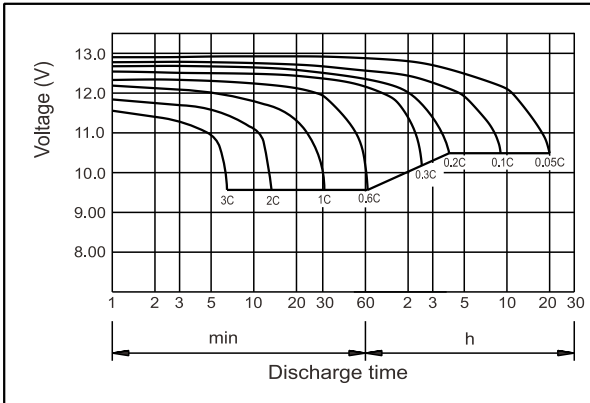

● Charging characteristics (25°C)

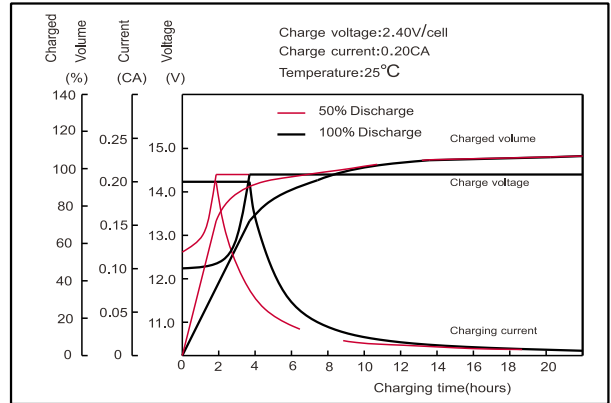

● Effect of temperature on capacity

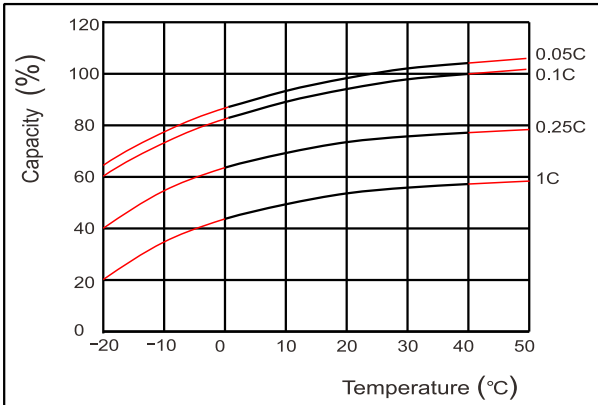

● Self-discharge characteristics

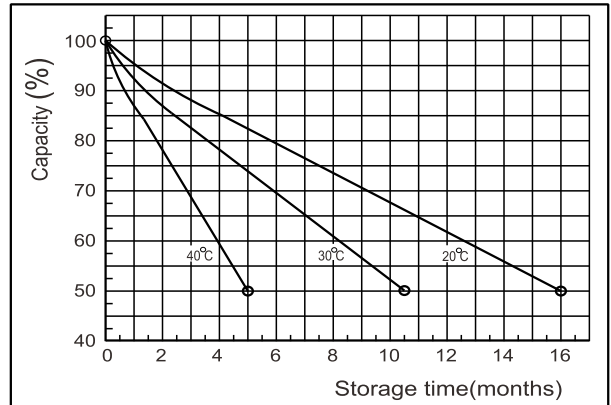

● Floating life on temperature

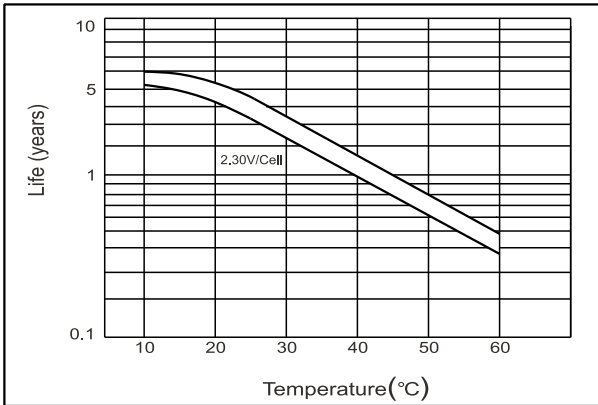

● Cycle life on D.O.D.(25°C)

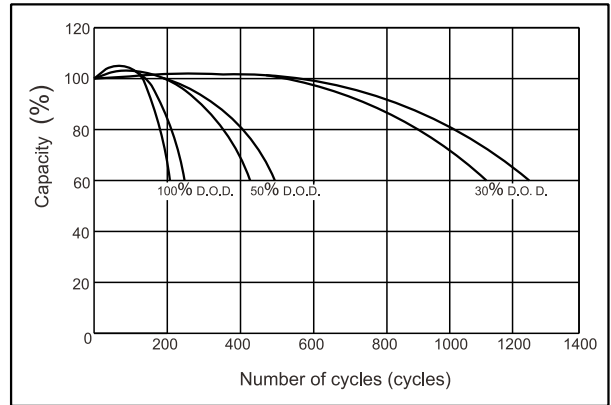

● The relationship for OCV and Capacity (25°C)

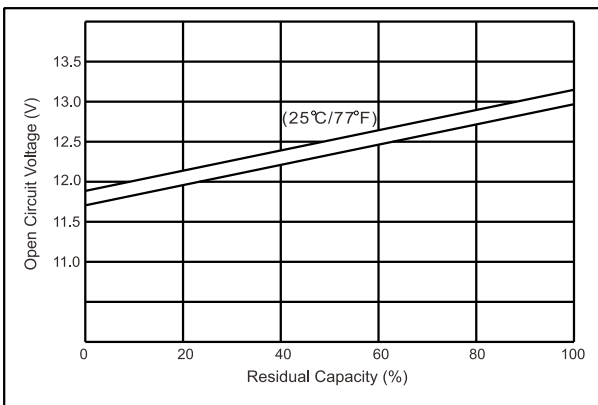

● The relationship for Charging voltage and Temperature

