

# MICRO INVERTER



## NEE-WNE300 USER MANUAL

..... Green Energy  
..... Smart Inverter **Expert** .....

### IoT Monitoring Platform

#### Smart mobile "core" life

- CO-2 induced environmental analysis
- Daily and total energy generation in kWh
- Actual DC input voltage, current and power
- Actual AC output voltage, current and power
- Inverter temperature
- Historical (daily, weekly, monthly) power curve
- Power losses due to weather induced effects
- Optional limitation of power output
- Online switch for the inverter start stop

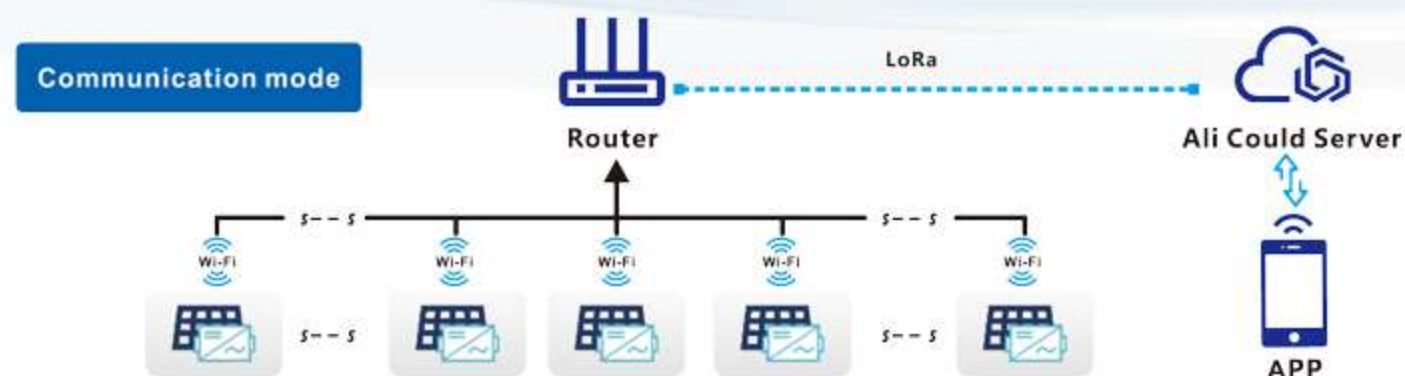

- |   |   |
|---|---|
| ☑ CO-2 induced environmental analysis         | 🌡 Inverter temperature                            |
| 🕒 Daily and total energy generation in kWh    | ⚙ Optional limitation of power output             |
| Ⓐ Actual DC input voltage, current and power  | 🔌 Online switch for the inverter start stop       |
| Ⓜ Actual AC output voltage, current and power | 📊 Historical (daily, weekly, monthly) power curve |



<b>model</b>	<b>NEE-WNE300</b>	
Recommend use panels	1*375Watt	
Output voltage mode	120/230V Auto switch	
PV Open circuit voltage	30-54VOC	
Operating voltage range	22-60V	
Starting voltage range	22-60V	
short-circuit current	15A	
Maximum working current	13.7A	

<b>Output parameters</b>	<b>@120V</b>	<b>@230V</b>
Output peak power	310Watt	310Watt
Rated output power	300Watt	300Watt
Output current	2.5A	1.3A
AC voltage range	80-160VAC	180-280VAC
AC frequency range	48-51Hz/58-61Hz	48-51Hz/58-61Hz
Power factor	>95%	>95%
Number of branch connections.	15PCS ( Single )	25PCS ( Single )

<b>Output efficiency</b>	<b>@120V</b>	<b>@230V</b>
Static MPPT efficiency	99.5%	99.5%
Max output efficiency	95%	95%
Loss of power at night	<0.5W	<0.5W
Total current harmonics	<5%	<5%

### Appearance and technical features

Temperature range	-40°C to +65°C	
Size ( L×W×H )	165mm×176mm×38mm	
Net amount	0.82kg	
Waterproof grade	Ip65 NEMA3R	
Heat dissipation mode	Self-cooling	
Communication mode	Wi-Fi	
Power transmission mode	Reverse transmission, Load priority	
monitoring system	APP	
Electromagnetic Detection	EN61000-6-1:2007 EN6100-6-3:2007+A1:2011+AC:2012	
Power Grid standard	EN50549-1、EN 50549-2、NBR 16149:2013、UL1741	
Power grid detection	IEC/EN 62109-1、IEC/EN 62109-2、IEC 62116、IEEE 1547	
Certificate	CE , Patented technology	

### Packing weight

Specifications	Each ( Packing )	Box ( 15PCS )
weight	1.28KG	19.5 KG
Size	245×202×60mm	450×395×345mm

### Detailed



Exterior



ANTENNA



SCREW KIT



USER MANUAL



AC PLUG

Accessories

### System diagram

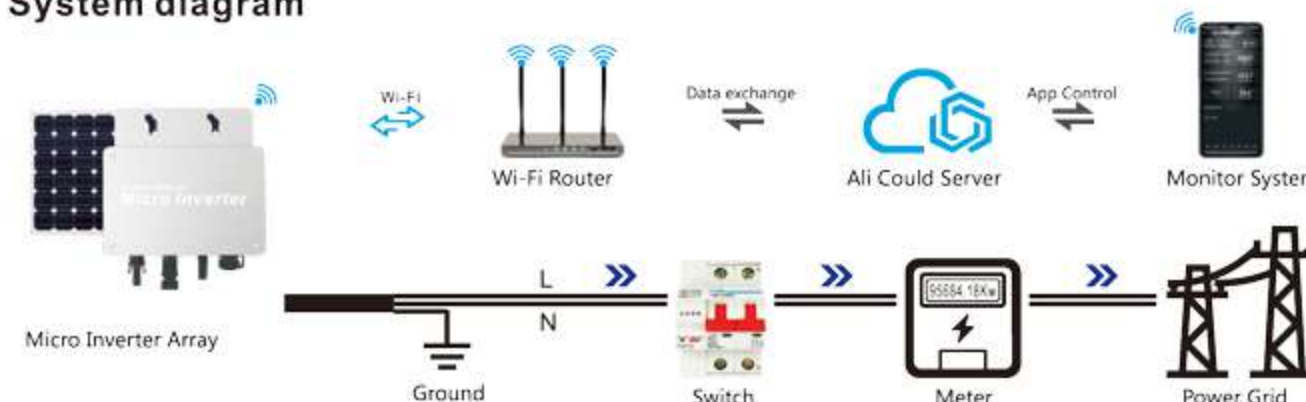

### Description of the connector and cable core of the micro inverter

3-N-Neutral 1-L-Live wire



2-G-Ground

Wire end connector

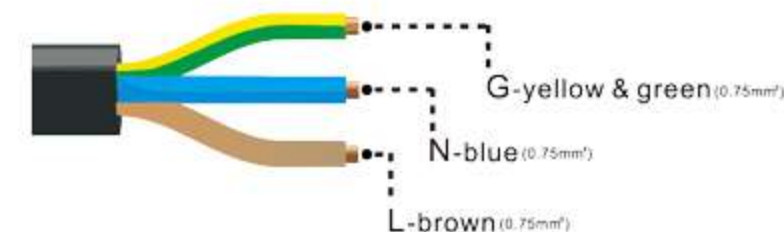

**Note:** You can purchase a professionally customized AC bus with a T-type connector. Use this AC bus as the AC bus for each branch. Connect it hand in hand to form a modular micro-inverter branch wiring system.

### LED indicator function of micro inverter

1. Red light keeps on -----The equipment enters the preparatory working state;
2. Red light flashes -----The device enters the delayed start-up state;
3. Blue light flashes quickly -----MPPT maximum power point search status;
4. Blue light keeps on-----MPPT maximum power point locked state;
5. Blue light turns to red light for a long time-----a) Island protection; b)Frequency protection; c)Fault; d) Software shutdown; e)AC voltage over-voltage protection; f)DC voltage over-voltage protection;

### Normal working indicator flashing process

Connect the micro-inverter correctly to the AC and DC terminals and then power on:  
The red light keeps on for 3 seconds → the red light flashes for 30 seconds → the blue light flashes quickly (MPPT maximum power point search) → the blue light keeps on, (MPPT lock).



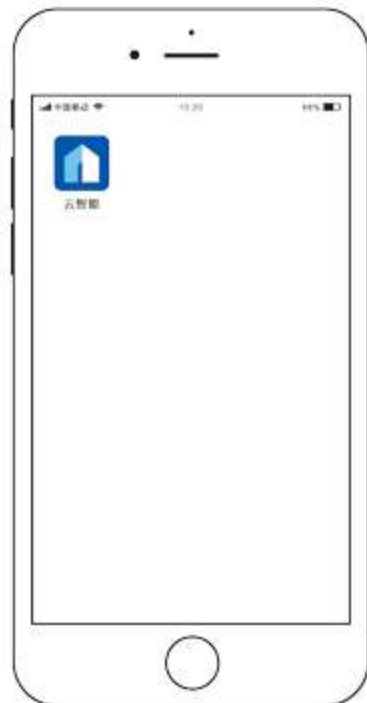

# DOWNLOAD Cloud Intelligence APP

Please use the QR code to scan and install the "Cloud Intelligence" client application, System version: Android 5.0, IOS 9 and above



## Note

Please strictly observe the following installation conditions

- a) Connect the communication antenna on the inverter;
- b) Put the inverter in a place with good Wifi signal;
- c) The connected Wi-Fi network needs to be in 2.4G mode;
- d) Please reset the inverter for the first use;



## Reset

Long press the reset button, when the LED indicator lights up again and turns into a "blue light" Release the reset button after the status is displayed for a long time, and the inverter will automatically complete the reset.

## 1 Add Device

Open the intelligent monitoring software "Cloud Intelligence" APP to log in Account, click the "+" icon in the upper right corner to start adding Equipment program; \*If there is a device under the current account, click on the device icon to enter the details page)



## 2 Entry equipment

When the smart APP changes to the QR code scanning state, scan the QR code label on the inverter body. At this time, the APP will automatically collect the inverter code and automatically jump to the Wi-Fi connection page, enter Click Next after the current Wi-Fi password;

## 3 Disribution network

Connect the inverter to the power supply as required, and quickly press the "Reset" button. At this time, the "LED" indicator will change to flashing blue and red alternately. At this time, the inverter enters the standby state of the distribution network;

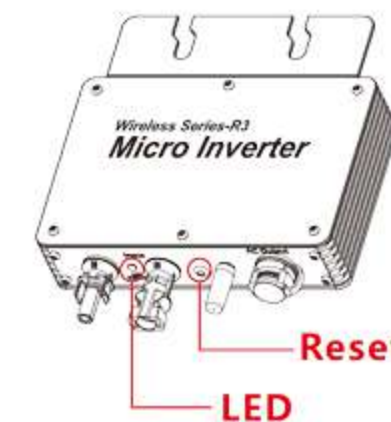



## 4 Initialization

When the inverter is in standby mode, return to the mobile phone APP to initialize the device operation page, check the "I have completed the above operations" below and click the "Start Connection" button. At this time, the page will jump to the signal search page. The LED indicator on the converter changes from red and blue alternately flashing state to "blue" long-bright display state when the network distribution is completed. The page will automatically jump to the system completion confirmation page, please click "Finish".

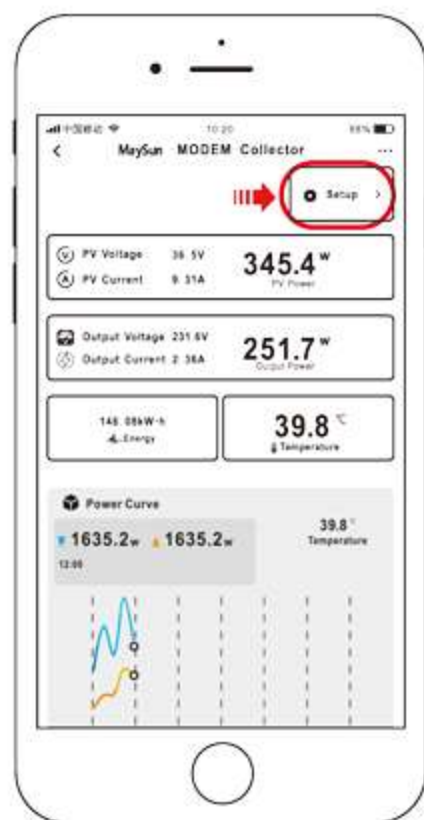
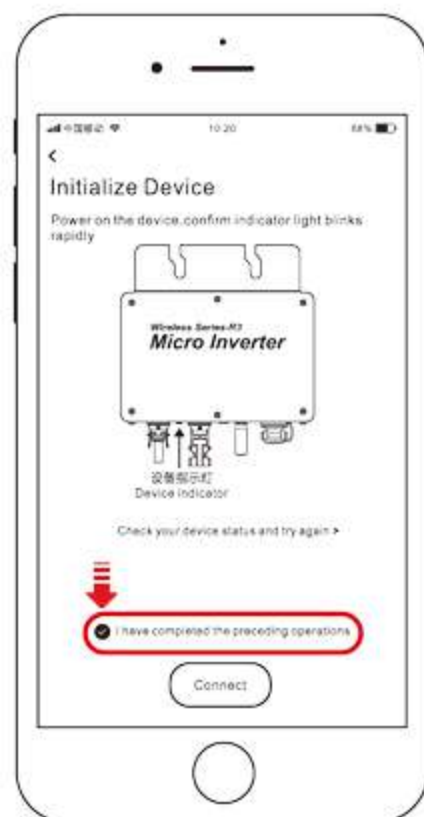

## 5 Inverter Control

Click the "Settings" button in the upper right corner of the system details page. In the settings page, you can adjust the inverter's output power, timing, remote start and stop, etc. according to actual needs.

### Remarks

1. When multiple inverters need to be added, theIn the English state, "," comma separated and ended. Such as: 60001234, 6000E312,
2. Each Modem can monitor 60 inverters at the same time;
3. A total of 2 lists, each list can be filled with 30 inverter codes;

## Features

Smart APP can realize real-time data transmission with the cooperation of Alibaba Cloud IoTThrough graphs and graphic displays in time, users can understand the operation of the power station. The user can monitor the operation and adjust the output power function of the system.

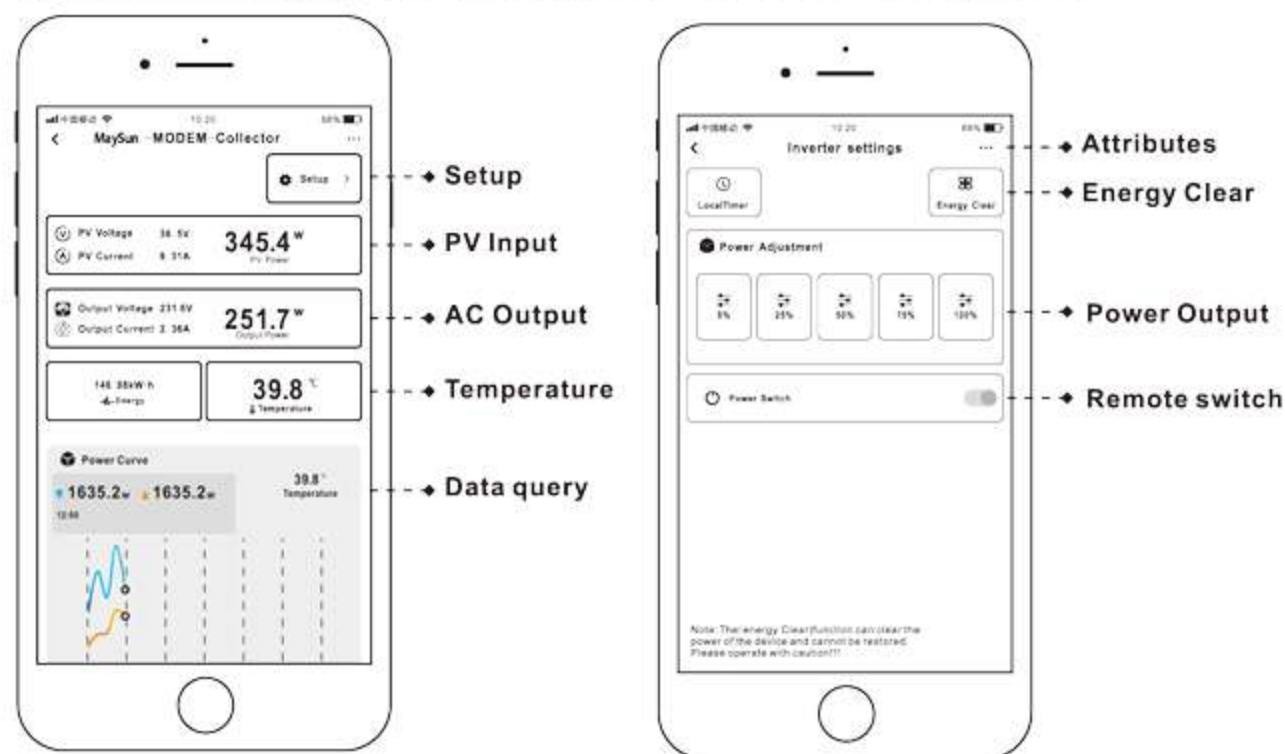

### INTELLIGENT IoT MONITORING MODEM

Number of data collectors per Modem

Built-in WiFi IoT data terminal

Can be used on any smart device (Android/iOS)

- CO-2 induced environmental analysis
- Daily and total energy generation in kWh
- Actual DC input voltage, current and power
- Actual AC output voltage, current and power
- Inverter temperature
- Historical (daily, weekly, monthly) power curve
- Power losses due to weather induced effects
- Optional limitation of power output
- Online switch for the inverter start stop